



**FIBA**

We Are Basketball

# 2024 OFFICIAL BASKETBALL RULES

**BASKETBALL RULES &  
BASKETBALL EQUIPMENT**

Valid as of **1<sup>st</sup> October 2024**

Rules adopted by the International Basketball Federation (FIBA)



# **Official Basketball Rules 2024**

## **Basketball Equipment**

As approved by

**FIBA Central Board**

Mies, Switzerland, 26<sup>th</sup> April 2024

Valid as of 1<sup>st</sup> October 2024

## TABLE OF CONTENTS

1	Backstop unit.....	6
1.1	Backboard .....	7
1.2	Basket ring.....	8
1.3	Basket net.....	10
1.4	Backboard support structure .....	10
1.5	Padding .....	11
2	Basketballs.....	12
3	Scoreboard/Videoboard .....	13
4	Game clock .....	15
5	Shot clock.....	15
6	Signals.....	16
7	Player foul and game disqualification (GD) markers .....	17
8	Team foul markers .....	17
9	Alternating possession arrow.....	18
10	Floor.....	18
11	Court.....	20
12	Lighting.....	20
13	Whistle-controlled timing system .....	25
14	Whistle.....	25
15	Advertising boards.....	26
16	Spectator areas.....	28
17	References.....	31

## TABLE OF DIAGRAMS

Diagram 1	Backstop unit level 1 (Shot clock option 1).....	6
Diagram 2	Backstop unit level 1 (Shot clock option 2).....	6
Diagram 3	Backboard markings.....	8
Diagram 4	Basket ring dimensions.....	8
Diagram 5	Attachment of the net (example).....	8
Diagram 6	Ring mounting plate (example dimensions).....	9
Diagram 7	Ring mounting plate for existing baskets (example dimensions) .....	9
Diagram 8	Backboard padding.....	11
Diagram 9	Scoreboard for Level 1 (example of the layout).....	14
Diagram 10	Shot clock display unit and duplicate game clock, for Level 1 (example of the layout).....	16
Diagram 11	Player foul and game disqualification markers (example of the layout) .....	17
Diagram 12a	Electronic team foul marker (example of the layout).....	17
Diagram 12b	Mechanical team foul marker (example of the layout).....	17
Diagram 13	Alternating possession arrow (example of the layout).....	18
Diagram 14	Court.....	20
Diagram 15	Advertising board padding .....	27
Diagram 16	Advertising boards – main camera table side .....	27
Diagram 17	Advertising boards – main camera opposite side .....	28
Diagram 18	Spectators' line of visibility .....	28
Diagram 19	Spectator seating recommendations .....	29

## LIST OF TABLES

Table 1	Basketball circumference and weight tolerances .....	12
Table 2	Scoreboard digit and character requirements .....	14
Table 3	Wooden flooring requirements (Level 1 and 2) .....	19
Table 4	Synthetic flooring requirements (Level 2) .....	19
Table 5	Illuminance requirements .....	21
Table 6	Lighting requirements .....	22
Table 7	Whistle volume and frequency requirements .....	25

# Basketball Equipment

## Introduction

The Basketball Equipment section of the Official Basketball Rules specifies all basketball equipment required at a game. Reference to Level 1 indicates that the equipment is essential and imperative for this level and recommended for Level 2. Reference to Level 2 competitions indicates that the equipment is essential and imperative for this level.

This Appendix shall be used by all parties involved directly in the game as well as by basketball equipment manufacturers, local organisers and FIBA for its equipment approval programme and to establish national and international standards.

For manufacturers and FIBA Accredited Test Institutes, all tests carried out for FIBA approved equipment shall follow the procedures specified in the FIBA Equipment and Venue Centre's Handbook of Test Methods and Requirements which can be acquired from the FIBA Equipment and Venue Centre.

The competitions are divided into two levels:

- **Level 1: FIBA National Team and Club Competitions plus other elite level national and international club and national team competitions.**

National club competitions may be subject to additional rules issued by national governing bodies. 'FIBA National Team and Club Competitions' are defined in Book 2 of the FIBA Internal Regulations governing the FIBA Competitions. All equipment at these competitions must be FIBA Approved Level 1 and may display the official FIBA Approved Equipment logo in a FIBA approved layout or make reference to FIBA approval in a FIBA approved form.

- **Level 2: Any other competition not included in Level 1.**

For Level 2 all technical specifications of basketball equipment must be respected, and FIBA approved equipment is strongly recommended.

## Notes:

1. This Appendix focuses on the requirements and specifications and does not describe testing procedures. The testing procedures and measurement tolerances can be found in the "Handbook of Test Methods and Requirements" which can be acquired from the FIBA Equipment and Venue Centre ([equipmentandvenue@fiba.basketball](mailto:equipmentandvenue@fiba.basketball)).
2. Installed equipment, which is not FIBA Approved, may undergo an onsite test in accordance with the FIBA Rules to gain temporary approval of the installed equipment. More details can be obtained from the FIBA Equipment and Venue Centre ([equipmentandvenue@fiba.basketball](mailto:equipmentandvenue@fiba.basketball)).
3. For the following equipment categories: Backstop Units, Scoreboards and Videoboard Software, Floor, Court lighting, Instant Replay System, Whistle Controlled Timing System and spectator seating, FIBA approved equipment is valid for the relevant level of competition up to 8 years after purchase regardless of its current FIBA approval status. After this 8-year period, any equipment no longer approved by FIBA must be replaced.
4. For FIBA 3x3 or Outdoor Basketball, refer to the Official 3x3 Basketball Equipment & Software Appendix – <https://fiba3x3.com/docs/equipment-and-software-appendix-to-the-3x3-official-rules.pdf>

# 1 Backstop unit

There shall be 2 backstop units, 1 placed at each end of the court and each consisting of the following parts:

- 1 backboard.
- 1 basket ring with a ring mounting plate.
- 1 basket net.
- 1 backboard support structure.
- Padding.

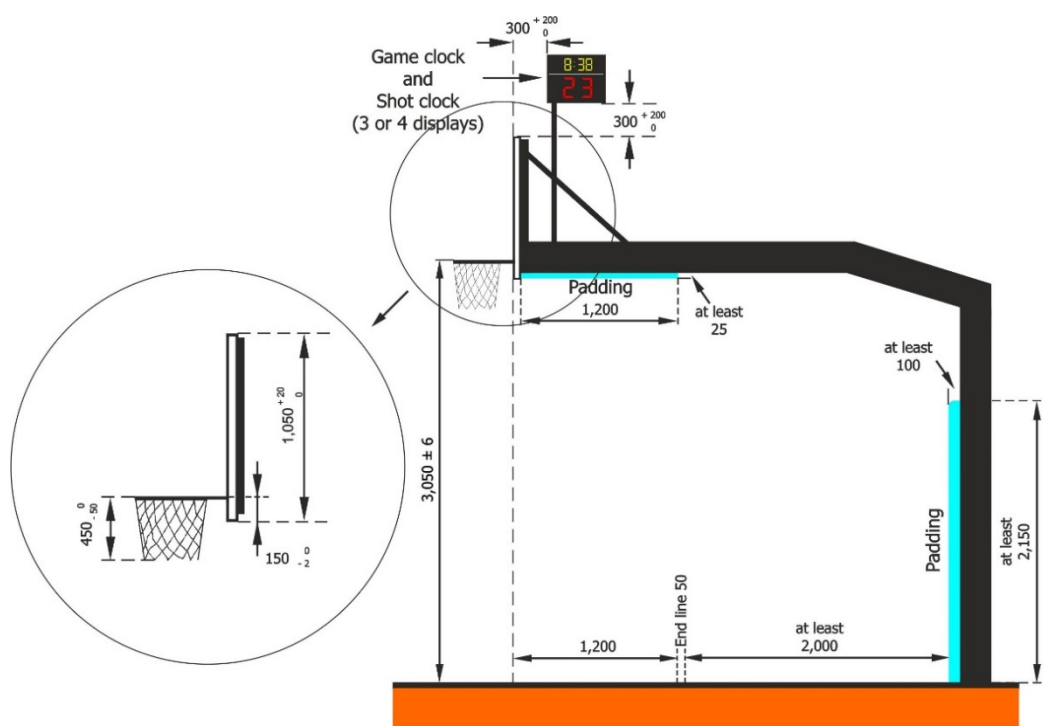

Diagram 1 Backstop unit level 1 (Shot clock option 1)

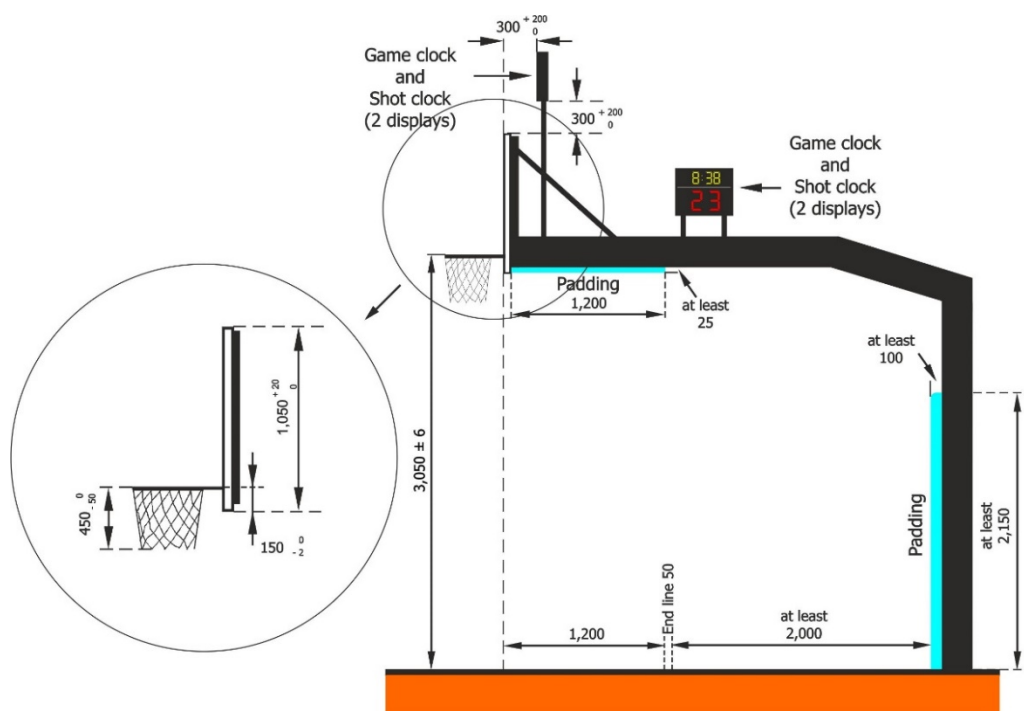
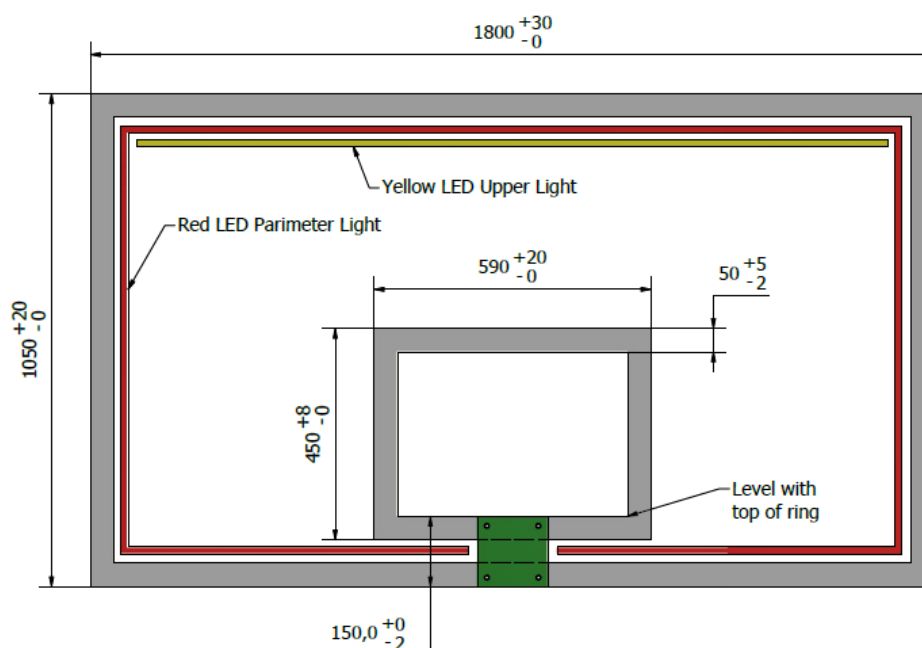

Diagram 2 Backstop unit level 1 (Shot clock option 2)

## 1.1 Backboard

- 1.1.1. For Level 1 the backboards shall be made of non-reflective laminated safety glass or tempered glass, with a thickness of between 11.8 mm and 13.5 mm, with a flat front surface and shall:
- Have a protective framework of the backboard support structure around the outer edge.
  - Be manufactured such that, if broken, the pieces of glass do not split off or cause any risk of injury.
- 1.1.2. For Level 2, the backboards may be any of the following:
- Laminated/tempered glass (identical to Level 1)
  - Transparent acrylic or polycarbonate
  - Wood, fiberglass, steel or aluminium, painted white.
- 1.1.3. The backboards shall measure 1,800 mm (+ a maximum of 30 mm) horizontally and 1,050 mm (+ a maximum of 20 mm) vertically, including the frame.
- 1.1.4. All lines on the backboards shall be:
- In white, if the backboards are transparent.
  - In black, if the backboards are painted white (Level 2 only).
  - 50 mm in width.
- 1.1.5. The borders of the backboards shall be marked with a boundary line (Diagram 3) and an additional rectangle behind the ring as follows:
- Outside dimensions: 590 mm (+ a maximum of 20 mm) horizontally and 450 mm (+ a maximum of 8 mm) vertically.
  - The top edge of the base of the rectangle shall be level with the top of the ring and 150 mm (- 2 mm) above the bottom edge of the backboard.
- 1.1.6. For Level 1, each backboard shall be equipped with a light strip around its perimeter, mounted on the inside borders of the backboards and which lights up in red only when the game clock signal sounds for the end of a quarter or overtime. The light strip shall be a minimum of 10 mm in width and cover a minimum of 90 % along the edge of the backboard glass area.
- 1.1.7. For Level 1, each backboard shall be equipped with a light strip along its perimeter at the top, mounted on the inside borders of the backboards, which lights up in yellow only when the shot clock signal sounds. The light strip shall be a minimum of 10 mm in width and be mounted directly below the red lighting for the game clock.
- 1.1.8. The backboards shall be firmly mounted on the backboard support structures at each end of the court at right angles to the floor, parallel to the endlines (Diagram 1 or 2). The central vertical line on their front surfaces, extended down to the floor, shall touch the point on the floor which lies 1,200 mm from the centre point of the inner edge of each endline, on an imaginary line drawn at right angles to this endline.
- 1.1.9. For Level 1, when a basketball is dropped onto the backboard, from 1.8 m, it shall rebound from it with a minimum rebounding height of 50 %.



**Diagram 3 Backboard markings**

## 1.2 Basket ring

1.2.1 The rings shall be made of solid steel and shall:

- Have an inside diameter of a minimum of 450 mm and a maximum of 459 mm.
- Be painted orange within the following Natural Colour System (NCS) or RAL CLASSIC spectrums:
 

NCS:	RAL:
S0580-Y70R (CMYK: 0, 63, 79, 4)	RAL 2004 (CMYK: 0, 65, 87, 0)
S0585-Y70R (CMYK: 0, 70, 92, 5)	RAL 2008 (CMYK: 0, 70, 90, 0)
S1080-Y70R (CMYK: 0, 65, 85, 13)	RAL 2010 (CMYK: 0, 78, 100, 0)
- Have its metal a minimum of 16 mm and a maximum of 20 mm in diameter.

1.2.2 The net shall be attached to each ring in 12 places. The fittings for the attachment shall:

- Not have any sharp edges or gaps,
- Have gaps smaller than 8 mm, to prevent fingers from entering,
- Not be designed as hooks for Level 1.

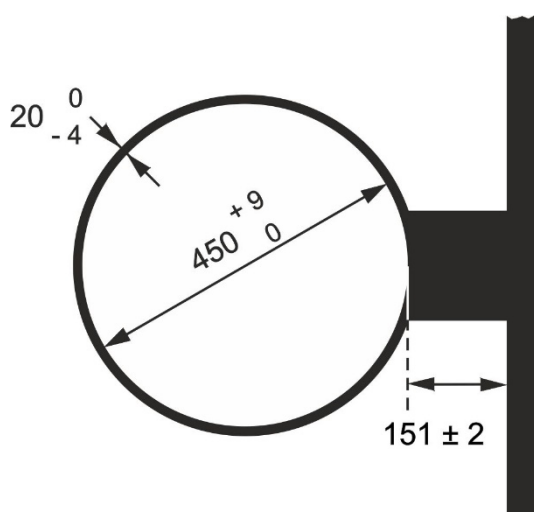

**Diagram 4 Basket ring dimensions**

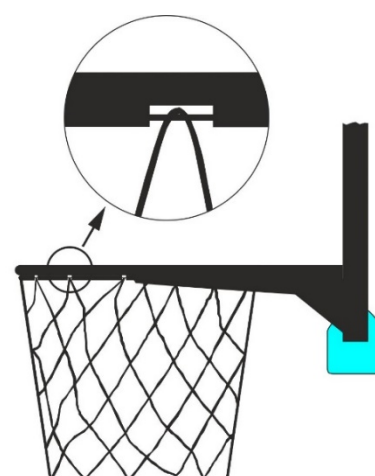

**Diagram 5 Attachment of the net (example)**



- 1.2.3 The rings shall be fixed to the backboard support structures in such a way that any force applied to the ring cannot be transferred to the backboard itself. Therefore, there shall be no direct contact between the ring mounting plate and the backboard (Diagram 6).
- 1.2.4 The top edge of each ring shall be positioned horizontally, 3,050 mm ( $\pm$  a maximum of 6 mm) above the floor, equidistant from the 2 vertical edges of the backboard.
- 1.2.5 The point on the inside circumference of the ring nearest the backboard shall be 151 mm ( $\pm$  a maximum of 2 mm) from the face of the backboard.

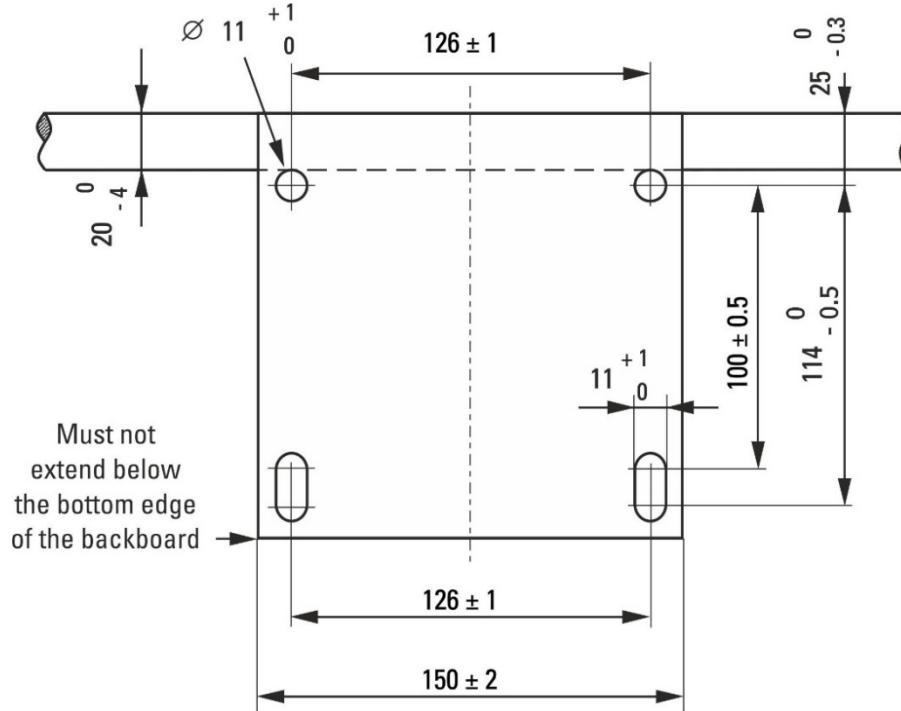

**Diagram 6 Ring mounting plate (example dimensions)**

- 1.2.6 For existing basket support structures, it is recommended that the ring mounting plate be fixed to the framework according to the measurements given in Diagram 7.

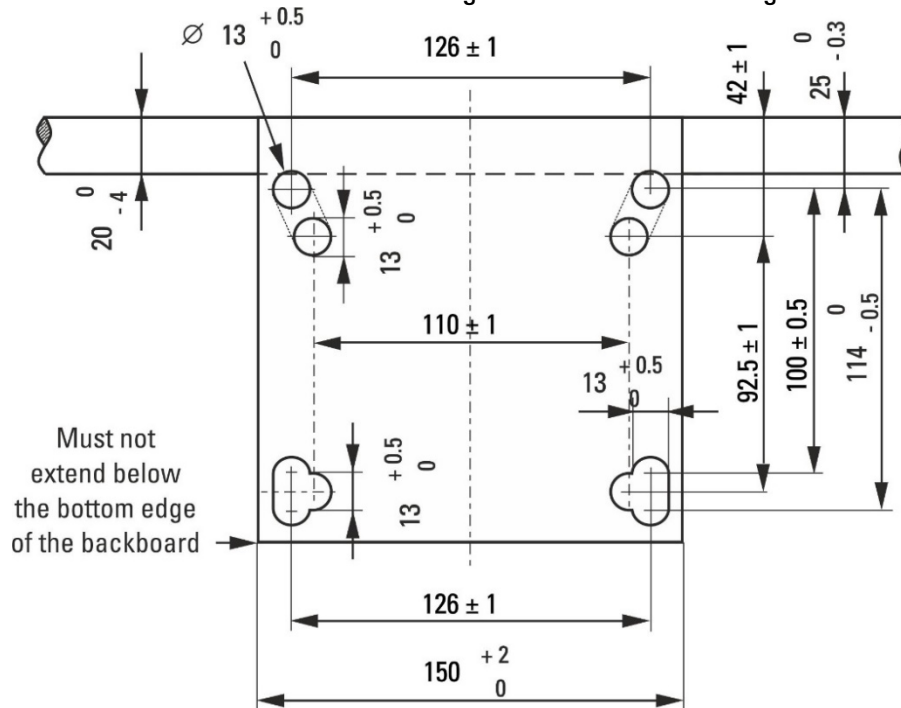

**Diagram 7 Ring mounting plate for existing baskets (example dimensions)**

- 1.2.7 Pressure release rings with the following specifications are required for Level 1 and also for Level 2 products requesting FIBA approval:
- The pressure release mechanism shall not cause any damage to either the ring or the backboard. The design of the ring and its construction shall be such that the players' safety is ensured.
  - For Level 1, the pressure release rings shall have a 'positive-lock' mechanism which must not disengage until a static load of a minimum of 82 kg and a maximum of 105 kg has been applied vertically to the top of the ring at the most distant point from the backboard. The pressure release ring mechanism shall be adjustable within the given static load range.
  - When the pressure release mechanism is released, the front or the side of the ring shall rotate no more than 30 degrees and no less than 10 degrees below the original horizontal position.
  - After release and with the load no longer applied the ring shall return automatically and instantly to its original position. No fissures and no permanent deformation of the ring shall be observed.
  - The rebound/elasticity of the ring and support system shall be within 35 % - 50 % energy absorption range of the total impact energy. Two opposing rings shall fall within 5% units of one another.

### **1.3 Basket net**

- 1.3.1 The nets shall be made of white cord and shall be:
- Suspended from the rings.
  - Manufactured so that they check the ball momentarily as it passes through the basket.
  - No less than 400 mm and no more than 450 mm in length.
  - Manufactured with 12 loops to attach it to the ring.
- 1.3.2 The upper section of the net shall be semi-rigid to prevent:
- The net from rebounding up through or over the ring, creating possible entanglement.
  - The ball from becoming trapped in the net or rebounding back out of the net.

### **1.4 Backboard support structure**

- 1.4.1 For Level 1, only mobile or floor-fixed backboard support structures shall be used. For Level 2, in addition to mobile or floor-fixed, ceiling mounted or wall mounted backboard support structures may also be used.
- 1.4.2 Ceiling mounted backboards shall not be used in venues where suspension height exceeds 10,000 mm in order to avoid excessive vibration in the support structure. It is recommended that safety straps are always installed with the ceiling mounted unit.
- 1.4.3 The backboard support structure shall be:
- For Level 1, at a distance of at least 2,000 mm, measured from the outer edge of the endline to the front of the backstop padding (Diagram 1 or 2).
  - For Level 2, at a distance of at least 1,000 mm, measured from the outer edge of the endline to the front of the backstop padding. For wall or ceiling mounted units this measurement shall be taken from the outer edge of the endline to the wall or nearest obstacle.

- Of a colour, that sufficiently contrasts with the background, so that it is clearly visible to the players.
- Secured to the floor so as to prevent any movement. If floor anchoring is not possible, sufficient ballast weight on the basket support base must be used to prevent any movement.
- Adjusted such as that once the top edge of the ring is at a height of 3,050 mm from the floor, this height cannot be changed.
- The rigidity of the backboard support structure with ring shall fulfil the requirements of EN 1270.
- The vibration of the backboard support unit in which the displacement exceeds 5 mm, shall last less than 4 seconds after a dunk shot.

## 1.5 Padding

- 1.5.1 The backboard and backboard support structure must be padded.
- 1.5.2 The padding shall be of a single solid colour and shall be the same colour on both backboards and support structures.
- 1.5.3 The backboard padding shall be 20 to 27 mm thick from the front, back and side surface of the backboards. The padding shall be 48 to 55 mm thick from the bottom edge of the backboards.
- 1.5.4 The backboard padding shall cover the bottom surface of each backboard and the side surface to a distance of 350 to 450 mm from the bottom. The front and back surface must be covered to a minimum distance of 20 to 25 mm from the bottom of each backboard.

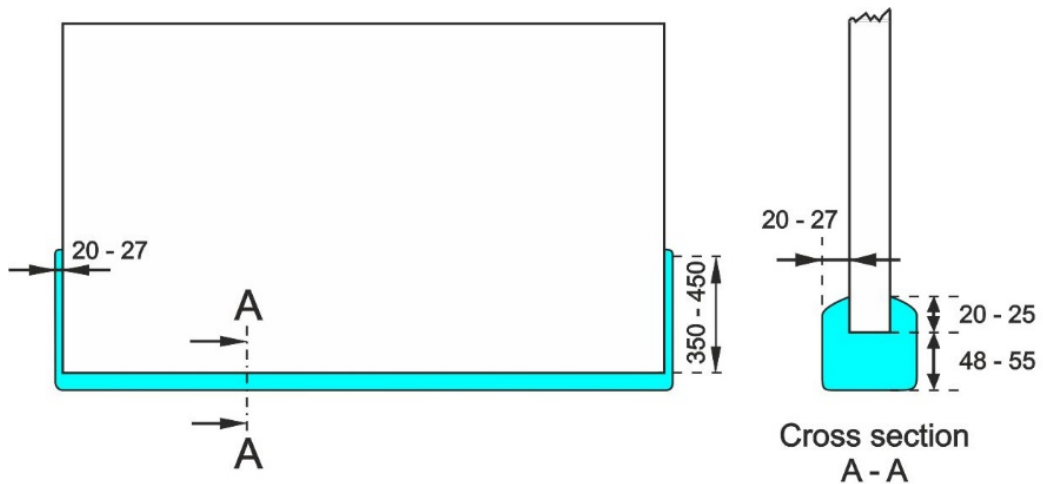

**Diagram 8 Backboard padding**

- 1.5.5 The padding of the backboard support structure shall cover:
- The vertical edges on each side, to a minimum height of 2,150 mm from the floor and with a minimum thickness of 100 mm (Diagram 1 or 2).
  - The bottom and side surfaces of the supporting arm of the backboard, from the back surface of the backboard over a minimum length of 1,200 mm along the arm, with a minimum thickness of 25 mm (Diagram 1 or 2).

- 1.5.6 To protect players during impact all padding shall:
- Be constructed so as to prevent limbs from being trapped.
  - Have a maximum indentation factor of 50 %. This means that when a force is applied suddenly to the padding, the indentation in the padding does not exceed 50 % of its original thickness.
  - Have a peak deceleration value of 500 m/s<sup>2</sup> or less.

## 2 Basketballs

- 2.1 For Level 1, the outer surface of the ball shall be made of leather or artificial/composite/synthetic leather.  
For Level 2, in addition to leather and artificial/composite/ synthetic leather, the outer surface of the ball may be made of rubber.
- 2.2 The surface of the ball shall comply fully with the relevant local and national legislation including adherence to any applicable safety directives regarding the use of toxic materials and materials which may cause an allergic reaction, including AZO-dyes, soluble heavy metals, Phthalate and PAH. It is the responsibility of the ball manufacturer to test their balls according to applicable legislation.
- 2.3 The basketball surface shall provide a proper grip over the entire ball.
- 2.4 The ball shall:
- Be spherical, with a maximum of 12 seams not exceeding 6.35 mm in width and, either of a single shade of orange or of a FIBA approved colour combination.
  - Be inflated to an air pressure such that, when it is dropped onto the floor from a height of approximately 1,800 mm measured from the underside of the ball, it shall rebound to a height of between 1,035 and 1,085 mm, measured to the underside of the ball.
  - Be marked with the recommended inflation pressure or pressure range.
  - Be marked with its respective size number.
  - Be within the circumference and weight tolerances outlined in Table 1. For all men’s competitions a size 7 ball shall be used; for all women’s competitions a size 6 ball shall be used; for all mini’s basketball a size 5 or size lightweight 5 ball shall be used.

Ball Size	7	6	5	Lightweight 5
Circumference	750 - 770 mm	715 - 730 mm	685 - 700 mm	685 - 700 mm
Weight	580 - 620 g	510 - 550 g	465 - 495 g	360 - 390 g

**Table 1 Basketball circumference and weight tolerances**

- 2.5 In addition to checking the specifications listed above, the ball shall meet the requirements of the following:
- Durability test
  - Loss of pressure test
  - Inflation stress test (Level 1 only)
  - Heat storage test (Level 1 only)

### **3 Scoreboard/Videoboard**

- 3.1 For Level 1, two large scoreboards or videoboards shall be:
- Placed one at each end of the court,
  - If there is a scoreboard (cube) placed above the centre of the court, one duplicate scoreboard on the opposite side of the players' benches, clearly visible to both teams, will be sufficient,
  - Clearly visible to everyone involved in the game, including the spectators.
- If video displays are used the complete required game information must be visible at any time during the game including intervals of play. The readability of the displayed information shall be identical compared to that of a digital scoreboard.
- 3.2 A game clock control panel shall be provided for the timer and a separate scoreboard control panel shall be provided for the assistant scorer. Computer panels may be used for entering data onto the scoreboard, however, to operate the equipment only dedicated control panels shall be used. Each panel shall enable easy correction of any incorrect data and have memory back-ups to save all game data for a minimum of 30 minutes.
- 3.3 The scoreboard shall include and/or indicate:
- The digital countdown game clock. The time remaining shall be displayed in minutes and seconds (mm:ss), except from during the last minute of each quarter or overtime where it shall be displayed in seconds and tenths of a second (ss:f).
  - The points scored by each team, and for Level 1 the cumulative points scored by each individual player.
  - For Level 1, the number of each individual player number (in the order 00, 0, 1, 2, 3, 4, 5, 6, 7, 8, 9, 10 and 11-99), and their corresponding surnames. There shall be a minimum of 12 digits to display each player's surname.
  - The team's names. There shall be a minimum of 3 digits to display each team's name.
  - For Level 1, the number of fouls committed by each player on the team from 1 to 5. The fifth foul shall be indicated in red or orange. The number may be shown with 5 indicators or a number display with a minimum height of 135 mm. In addition, the fifth foul may be indicated with a slow flashing display (~ 1 Hz) for 5 seconds. It shall be possible to display on the scoreboard the team fouls independently from the player's fouls.
  - The number of team fouls from 1 to 4 and a square displayed fully in red (instead of the team foul numbers) after the ball becomes live again after the fourth team foul in the quarter (Diagram 9). The red square shall be a square in shape with the sides between 80% and 120% of the team foul digit width.
  - The number of the quarter from 1 to 4, and 0 for an overtime.
  - The number of charged time-outs from 0 to 3. When the game clock shows 2:00 minutes or less in the fourth quarter, that team shall have only 2 more time-outs to be taken. All other time-outs shall be displayed as taken.
  - A clock for timing the time-out (optional). The game clock must not be used for this purpose.

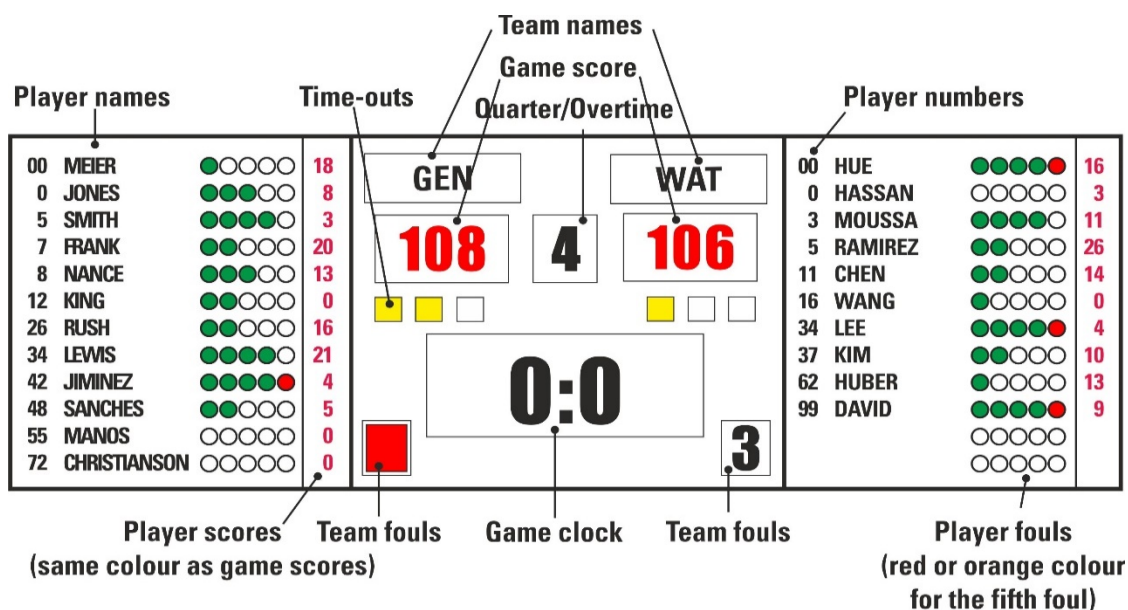

**Diagram 9 Scoreboard for Level 1 (example of the layout)**

- 3.4 For Level 1 (obligatory) and Level 2 (recommended):
- The display on the scoreboard shall be in bright contrasting colours.
  - The background of the display shall be antiglare.
  - The scoreboard game clock, game scores and the shot clocks shall have a minimum viewing angle of 130°.
  - The scoreboard digits and characters shall meet the size requirements specified in Table 2.
- 3.5 The scoreboard shall:
- Not have any sharp edges or burrs.
  - Be mounted securely.
  - Have specific protection, if necessary, which shall not impair the readability of the scoreboard.
  - Have electromagnetic compatibility in accordance with the statutory requirements of the respective country.

	Obligatory for Level 1	Recommended for Level 2 (obligatory for Level 2 products requesting FIBA approval)
<b>Game clock, Score</b>	Height ≥ 300 mm Width ≥ 150 mm	Height ≥ 250 mm Width ≥ 125 mm
<b>Game period, Team fouls</b>	Height ≥ 250 mm Width ≥ 125 mm	Height ≥ 200 mm Width ≥ 100 mm
<b>Team names</b>	Height ≥ 150 mm Min. 3 digits	Height ≥ 100 mm Min. 3 digits
<b>Time-outs</b>	3 indicator lights	3 indicator lights
<b>Player names</b>	Height ≥ 150 mm Min 12 digits	N/A
<b>Player numbers</b>	Height ≥ 150 mm	N/A
<b>Player fouls</b>	5 indicator lights or height ≥ 135 mm	N/A
<b>Player scores</b>	Height ≥ 150 mm	N/A

**Table 2 Scoreboard digit and character requirements**

- 3.6 Level 1 scoreboards requesting FIBA approval, shall comply with the FIBA Standard Scoreboard Protocol. The protocol describes a standard output from the Scoreboard to the TV Graphics system and can be obtained from the FIBA Equipment and Venue Centre ([equipmentandvenue@fiba.basketball](mailto:equipmentandvenue@fiba.basketball)).

## **4 Game clock**

- 4.1 For Level 1, the main game clock (Diagram 9) shall:
- Be a digital countdown clock with an automatic signal sounding for the end of the quarter or overtime as soon as the display shows zero (0.0).
  - Have the ability to indicate time remaining in minutes and seconds; as well as tenths (1/10) of a second only during the last minute of the quarter or overtime.
  - Be placed so that it is clearly visible to everyone involved in the game, including the spectators.
- 4.2 If the main game clock is placed above the centre of the court, one duplicate game clock on the opposite side of the players' benches, clearly visible to both teams, will be sufficient. Each duplicate game clock shall display the score and the playing time remaining throughout the game.
- 4.3 A whistle-controlled time system, interfaced with the connector equipped game clock may be used by the referees to stop the game clock, provided that this system is used in all of the games of a given competition. The referees shall also start the game clock, however this is, at the same time, also done by the timer. All FIBA approved Level 1 scoreboards may provide the interface with the whistle-controlled system.

## **5 Shot clock**

- 5.1 The shot clock shall have:
- A separate control unit provided for the shot clock operator, with a very loud automatic signal to indicate the end of the shot clock period.
  - A display unit with a digital countdown, indicating the time in seconds.
- 5.2 For Level 1 the shot clock shall indicate the time remaining in seconds; and tenths (1/10) of a second only during the last 5 seconds of the shot clock period.
- 5.3 The shot clock shall have the ability to be:
- Started from 24 seconds.
  - Started from 14 seconds.
  - Stopped with the display indicating the time remaining.
  - Restarted from the time at which it was stopped.
  - Showing no display, if necessary.
- 5.4 Be able to withstand direct impacts from basketballs, according to the Shot Clock Durability Test.
- 5.5 For Level 1 the shot clock shall be connected to the game clock so that when:
- The game clock stops, the shot clock shall also stop.
  - The game clock starts, it is possible to start the shot clock manually.
  - The shot clock stops and sounds, the game clock count continues and may be stopped, if necessary, manually.
- 5.6 For Level 1 the shot clock display unit (Diagram 10), together with a duplicate game clock shall:



- Be mounted on each backboard support structure a minimum of 300 mm above and behind the backboard (Diagram 1 or 2) or hung from the ceiling.
- Have the numbers of the shot clock in red colour and the numbers of the duplicate game clock in yellow colour.
- Have the numbers of the shot clock display a minimum height of 230 mm and be larger than the numbers of the duplicate game clock.
- Have 3 or 4 display surfaces per unit or two units with double sided surface (recommended for Level 2) to be clearly visible to everyone involved in the game, including the spectators.
- Have the maximum weight of 60 kg, including the support structure.
- Be equipped with a light strip around its perimeter (optional), which lights up in red only when the game clock signal sounds for the end of a quarter or overtime.
- Be equipped with a light strip along its perimeter at the top (optional), which lights up in yellow only when the shot clock signal sounds and be mounted directly below the red light strip for the game clock.
- Have electromagnetic compatibility in accordance with the statutory requirements of the respective country.

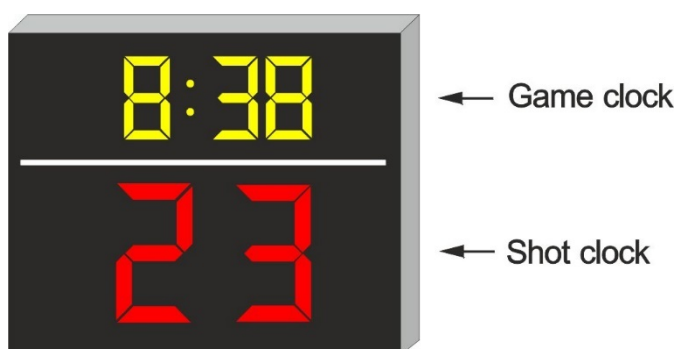

**Diagram 10** Shot clock display unit and duplicate game clock, for Level 1 (example of the layout)

## 6 Signals

- 6.1 There shall be at least 2 separate sound signals, with distinctly different and very loud sounds:
- One provided for the scorer which shall sound automatically to indicate the end of the playing time for a quarter or overtime. The scorer shall be able to sound the signal manually when appropriate to attract the attention of the referees.
  - One provided for the shot clock operator which shall sound automatically to indicate the end of the shot clock period.
- 6.2 Both signals shall be sufficiently powerful to be easily heard above the most adverse or noisy conditions. The sound volume shall have the ability to be adapted according to the size of the sport hall and the noise of the crowd, to a maximum sound pressure level of 120 dBA measured at a distance of 1 m from the source of the sound. A connection to the public information system of the sports hall is strongly recommended.



## 7 Player foul and game disqualification (GD) markers

- 7.1 The 5 player foul markers provided for the timer shall be:
- Of white colour.
  - With numbers a minimum of 200 mm in height and 100 mm in width.
  - Numbered from 1 to 5 (1 to 4 in black and the number 5 in red) on both sides.
- 7.2 The game disqualification (GD) marker provided for the timer shall be:
- Of red colour.
  - With letters GD in white, with a minimum of 200 mm in height and 100 mm in width, on both sides.

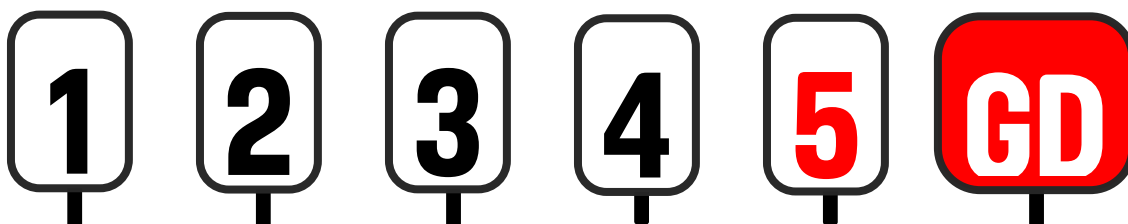

Diagram 11 Player foul and game disqualification markers (example of the layout)

## 8 Team foul markers

Electronic team foul markers are recommended, in particular for Level 1. The below specifications apply to both electronic and mechanical team foul markers.

The 2 team foul markers on the scorer's table, provided for the timer shall be:

- A minimum of 250 mm in height and of 125 mm in width.
- Clearly visible to everyone involved in the game, including the spectators, when positioned on either side of the scorer's table.
- Used to indicate the current number of team fouls from none up to 4. It shall be fully in red with no number visible, after the ball becomes live again after the fourth team foul in a quarter, indicating that the team has reached the team foul penalty situation.

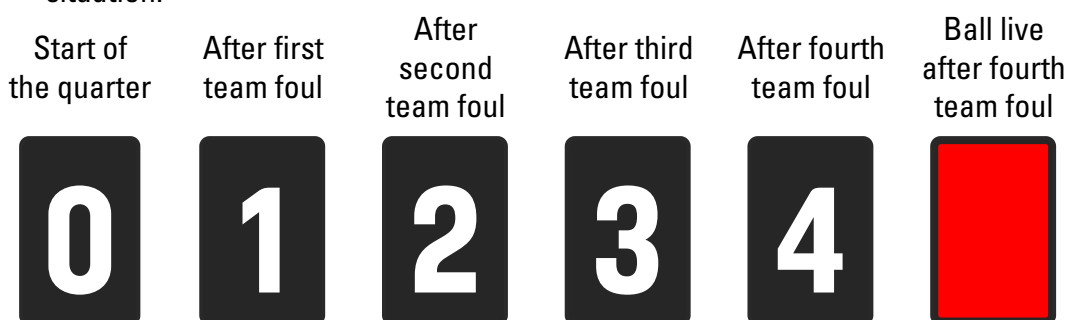

Diagram 12a Electronic team foul marker (example of the layout)

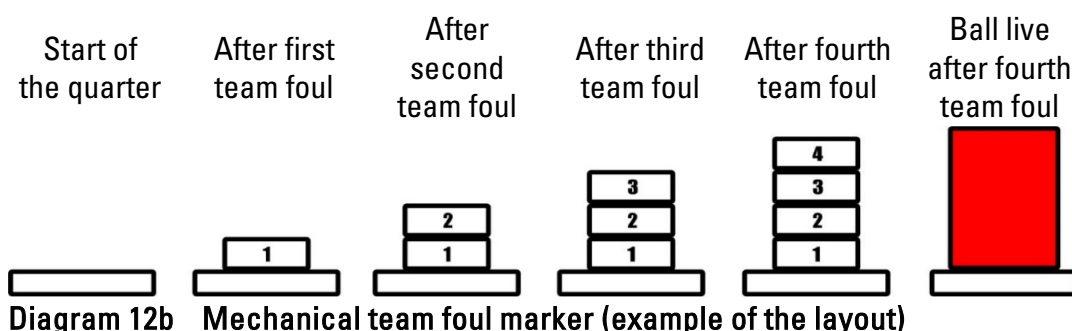

Diagram 12b Mechanical team foul marker (example of the layout)

## 9 Alternating possession arrow

The alternating possession arrow device (Diagram 13) provided for the scorer shall:

- Have an arrow of a minimum length of 100 mm and height 100 mm.
- Display on the front side an arrow, illuminated in bright red colour when switched on, showing the direction of the alternating possession.
- Be positioned in the centre of the scorer's table and shall be clearly visible to everyone involved in the game, including the spectators.

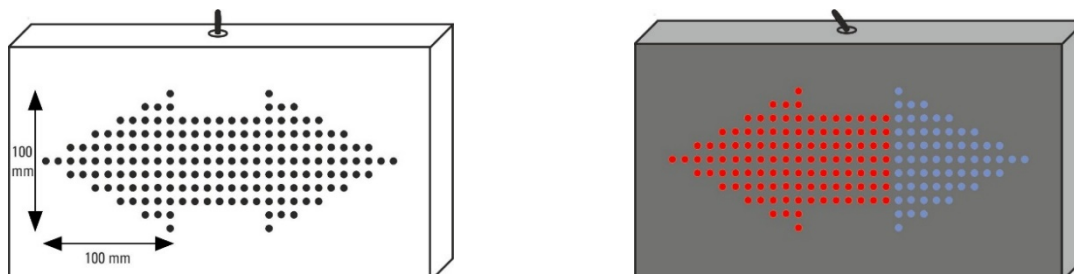

Diagram 13 Alternating possession arrow (example of the layout)

## 10 Floor

10.1 The floor surface shall be made of:

- Permanent or Mobile Wooden flooring (Levels 1 and 2).
- Permanent or Mobile Glass Flooring (Levels 1 and 2).
- Permanent or Mobile Synthetic flooring (Level 2).

10.2 The floor shall:

- Be a minimum length of 32,000 mm and a minimum width of 19,000 mm.
- Have an antiglare surface.

10.3 The flooring must adhere to the following sports functional requirements:

Performance property	Level 1 Permanent flooring	Level 1 Mobile flooring	Level 2 Permanent and mobile flooring
Force reduction, according to EN 14808	≥ 50 % - ≤ 75 %		≥ 40 % - ≤ 75 %
	Uniformity (absolute): (± 5 % from average)		
Vertical deformation, according to EN 14809	≥ 2.3 mm - ≤ 5.0 mm	≥ 1.5 mm - ≤ 5.0 mm	≥ 1.5 mm - ≤ 5.0 mm
	Uniformity: (± 0.7 mm from average)		

Ball rebound, according to EN 12235	≥ 93 %	≥ 93 %	≥ 90 %
	Uniformity (absolute): (± 3 % from average)		
Slip resistance, according to EN 13036	Average: ≥ 80 - ≤ 110		
Resistance to wear, according to EN 5470	≤ 80 mg		≤ 100 mg

<b>Specular gloss (%)</b>	$\leq 45\%$ *	N/A
	Uniformity ( $\leq 10$ -unit variance)	
<b>Rolling load, according to EN 1569</b>	Permanent indentation of $\leq 0.5$ mm	

**Table 3 Wooden and Glass flooring requirements (Level 1 and 2)**

\* Recommended value to minimize court glare for player's vision and TV production. High-gloss alternatives may be used when lighting is positioned as such to avoid unwanted court glare (see Section 12 Lighting).

<b>Performance Property</b>	<b>Level 2 Permanent and mobile flooring</b>	
<b>Force reduction, according to EN 14808</b>	Point Elastic: 25 % - 75 %	Uniformity (absolute) $\pm 5\%$ from average
	Mixed Elastic: 45 % - 75 %	
	Area Elastic: 40 % - 75 %	
	Combined Elastic: 45 % - 75 %	
<b>Vertical deformation, according to EN 14809</b>	Point Elastic: $\leq 3.5$ mm	Uniformity $\pm 0.7$ mm from average
	Mixed Elastic: $\leq 3.5$ mm	
	Area Elastic: 1.5 mm – 5.0 mm	
	Combined Elastic: 1.5 mm - 5.0 mm	
<b>Ball rebound, according to EN 12235</b>	$\geq 90\%$	
	Uniformity (absolute) $\pm 3\%$ from average	
<b>Slip resistance, according to EN 13036</b>	Average: $\geq 80 - \leq 110 \leq 1,000$ mg	
<b>Resistance to wear, according to EN 5470</b>	$\leq 1,000$ mg	
<b>Specular gloss (%)</b>	N/A	
<b>Rolling load, according to EN 1569</b>	Permanent indentation of $\leq 0.5$ mm	

**Table 4 Synthetic flooring requirements (Level 2)**

The requirements for the above properties have to be fulfilled at each system testing spot.

- 10.4 The manufacturer, together with the flooring installation company, shall be obliged to produce documentation for each customer comprising of at least the following: Results of the prototype test, a description of the installation procedure, maintenance advice, results of the inspection and approval of the existing installation carried out by approved inspection officials.
- 10.5 The floor must have the ability to carry mobile or floor-fixed backboard support structures without degrading the characteristics of the backboard support structure. Conversely, the mobile backboard support structures must be constructed in such a way that their weight is spread over a bigger contact area, thus eliminating the risk for damage to the floor, both in game position and during transportation on the court.

- 10.6 When stickers or paints are to be applied to the floor and not covered by an additional coat of finish, they must adhere to the same slip performance and specular gloss criteria as ordinary floor areas as defined in Table 3 and Table 4.

## 11 Court

- 11.1 The court shall be marked by:
- 50 mm lines, as per the Official Basketball Rules.
  - A further boundary lane (Diagram 14), in a sharply contrasting colour and having a minimum width of 2,000 mm.
- 11.2 The scorer's table, a minimum of 6,000 mm in length and 800 mm in height, must be placed on a platform of a minimum of 200 mm in height.
- 11.3 All spectators must be seated at a distance of at least 2,000 mm from the outer edge of the boundary line of the court.
- 11.4 The height of the ceiling or the lowest obstruction above the court shall be a minimum of 7 m.

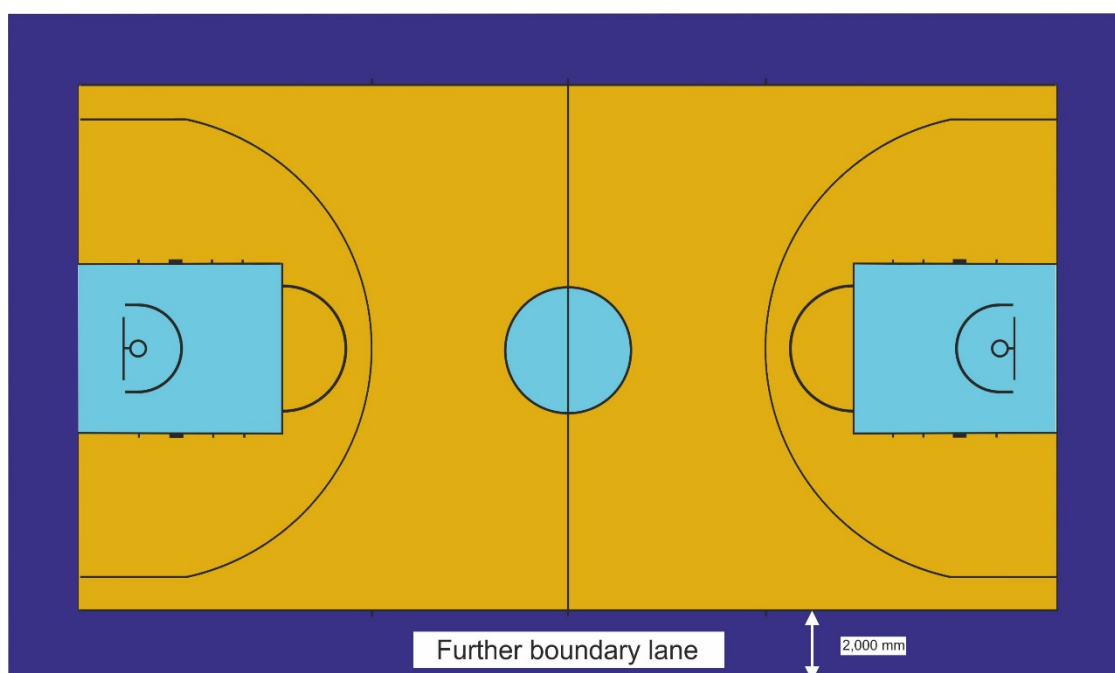

Diagram 14 Court

## 12 Lighting

- 12.1 The vertical illuminance (EC) (illuminance towards the main camera) and (EV) (illuminance towards the mobile cameras) are a key parameter for the picture quality. If there are varying levels of vertical illuminance at different positions on the court, then it can be disturbing when panning the camera. It is therefore essential that there is total uniformity in the distribution of the vertical illuminance over the entire court (also called uniformity of the vertical illuminance).

The vertical illuminance shall be kept as constant as possible in the four main directions facing the sides of the court where the cameras are generally located.

The horizontal illuminance (EH) is the quantity of light falling on the court. As the illuminated court is the principal part of the camera's field of view, the horizontal illuminance shall be as uniform as possible and the ratio between the average

horizontal illuminance and the average vertical illuminance towards the main camera shall be kept to a level that ensures a good quality contrast of the pictures.

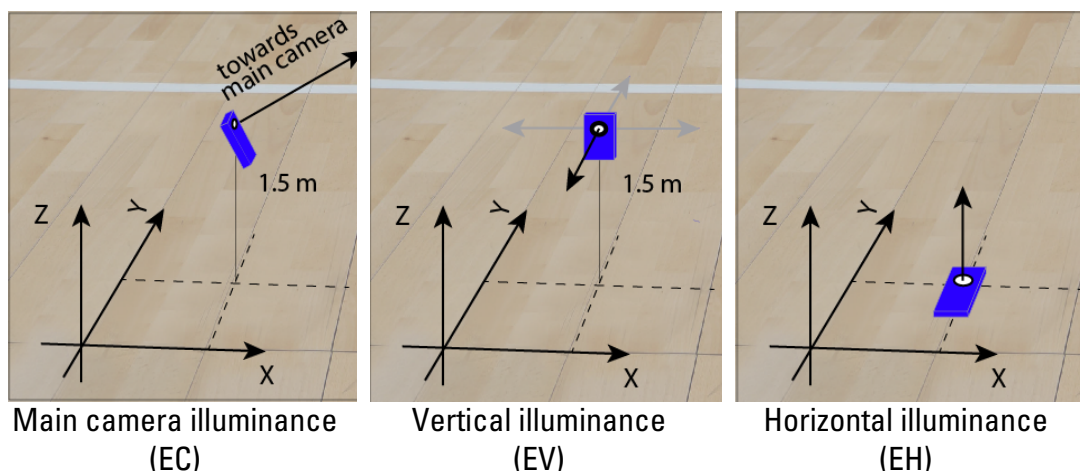

## 12.2 Lighting requirements and recommendations

The venue lighting must be designed for television broadcasting while minimising the glare for players and referees.

### 12.2.1 Illuminance level

- The court shall be uniformly and adequately lit. The illuminance level must be calculated and shall comply with the values specified in Table 5.
- Distinction shall be made between the Principal Playing Area (PPA) which represents the court including the further boundary lane (19 m x 32 m) and the Total Playing Area (TPA) which includes a 1.5 m wide area around the court, including the team benches (22 m x 35 m). Annex 1 shows the grid point to be used for the calculations and the typical camera positions. Average values are maintained values.
- No calculations are required for the Beauty Shot camera.

	EC: Main camera illuminance			EV: Vertical illuminance (all directions)				EH: Horizontal illuminance		
	Avg (lux)	Min/Max	Min/Avg	Avg (lux)	Min/Max	Min/Avg	Min/Max 4x Directions	Avg (lux)	Min/Max	Min/Avg
<b>PPA</b>	2000	0.7	0.8	1700	0.7	0.8	0.6	1500-3000	0.7	0.8
<b>TPA</b>	2000	0.6	0.7	1700	0.6	0.7	0.6	1500-3000	0.6	0.7

**Table 5** Illuminance requirements

### 12.2.2 Glare towards the main camera

The reflections of bright light sources on the court can cause bright spots which will affect the camera picture as illustrated below. Glare caused by high intensity light bouncing off the highly reflective glossy court surfaces towards the main camera position must be avoided especially on all court lines.



Careful attention to the simple necessary geometry will often eliminate these unwanted reflected images (see Annex 2).

### 12.2.3 Glare

It is essential that there is no glare whatsoever that affects the view of the basketball players when they are playing. The lighting positions and direction shall be defined in such a way as to take account of the players' view (See Annex 2). The intensity of the light source must be adapted in relation to the installation height.

### 12.2.4 Spectator areas

The average illuminance towards the main camera for the first 15 rows of seats shall be between 10 % and 25 % of the average illuminance on the court; the illuminance beyond the first 15 rows shall then uniformly reduce.

### 12.2.5 Light source

Flicker Factor, Colour Rendering and Colour Temperature are described below. Each point of the TPA shall meet the requirements stated in Table 6.

- The term flicker factor refers to the modulation of luminance on a given plane over a complete cycle. It denotes the relationship between the maximum and minimum illuminance at a point over a period of time (full cycle) and is expressed as a percentage. This flicker in lighting can negatively affect the quality of broadcasted imagery particularly in instances where slow-motion is utilised. The intensity of discharge lamps (generally used in sports lighting applications) fluctuates if supplied with an electromagnetic gear due to the 50 Hz or 60 Hz supply voltage frequency.
- The Colour Rendering Index (CRI) of a light-source is a quantitative value measuring its ability to reveal an objects colour when compared to an ideal or natural light-source. The CRI value is an important factor both for broadcasting quality as well as for venue spectators.
- Colour Temperature describes the output of lighting systems in terms of how warm (red) or cool (blue) the light appears. Television broadcasters require a constant colour temperature.

Flicker Factor	Colour Rendering (CRI)	Colour Temperature (K)	
≤ 1 %	≥ Ra 80	4000 - 6000	± 500 K from avg

**Table 6** Lighting requirements



The full court lighting shall be turned on at least 90 minutes prior to the start of the game and maintained until the prescribed requirements for pre-game warm-ups and game play. It shall remain fully lit for at least 30 minutes after the game.

Spotlight introductions for the teams or special ceremonies and entertainment can only be used if the lighting system has instant restrike capabilities which will not alter the light source colour properties.

### 12.2.6 Visual Inspection

A visual inspection shall be carried out to evaluate the lighting installation.

No reflected light shall be visible when standing at the main camera position. As TV cameras are more sensitive than the human eye, this can be checked by taking pictures with a digital camera. Attention shall be paid to floodlight illuminances wherever they may be located. The players must not be dazzled especially when they are looking at the baskets.

### Annex 1 – Grid Point for calculations and typical camera position

⊕
⊕ ⊕  
 Beauty Camera                      Main Cameras

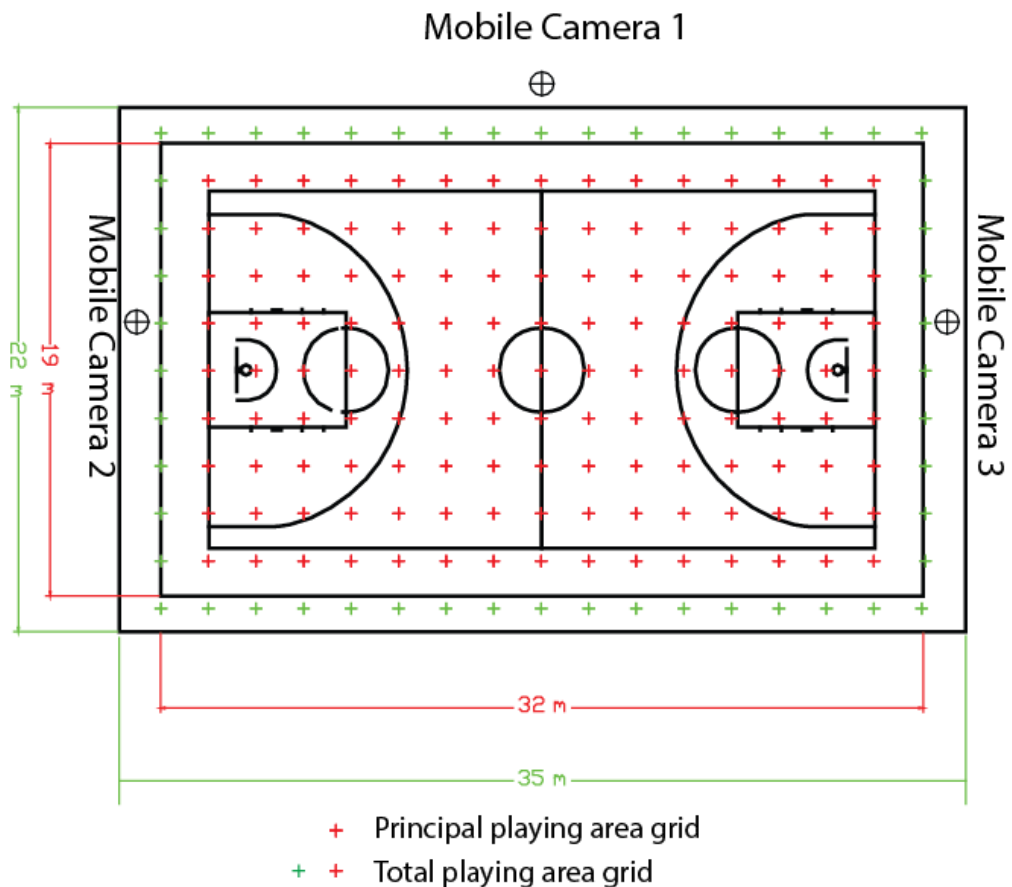

## Annex 2 – Recommendation for lighting positions

The location of the floodlights is critical to comply with the lighting requirements. It must ensure that the lighting requirements can be achieved, while not interfering with the players' visibility as well as not creating any glare towards the main camera.

Freedom shall be given to the lighting designer to position the floodlights to provide the best technical solution. It is highly recommended to have a lighting specialist involved in the project from the initial stage.

When the main camera position has been determined, the sources of glare can be minimised by avoiding the installation of floodlights in the forbidden area as shown in the figure below.

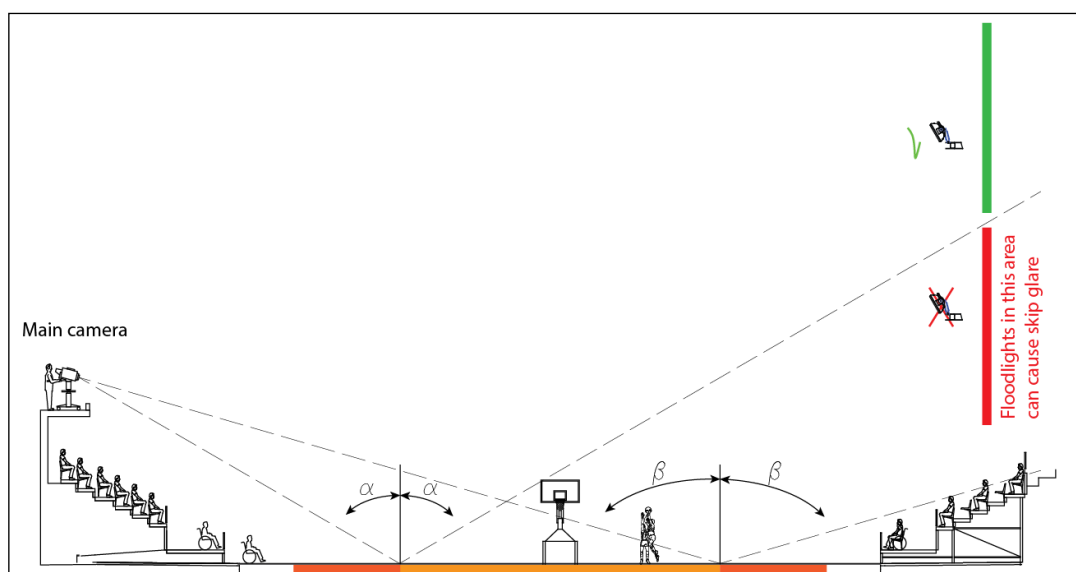

Forbidden area for lighting mountings to avoid glare towards the main camera

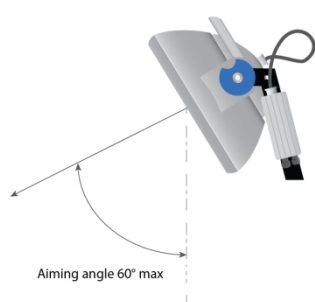

The lighting aiming angle (measured from downward vertical) shall ideally be  $\leq 60^\circ$  in order to minimise the glare to the players.

Careful attention shall be paid to the floodlight positioning with regards to their aiming directions which shall not interfere with the players vision, especially when they are shooting at the baskets.

The following example illustrates a critical location for floodlights. In this example, the floodlights located in the  $20^\circ$  area shall not be aimed directly towards any player in a shooting position.



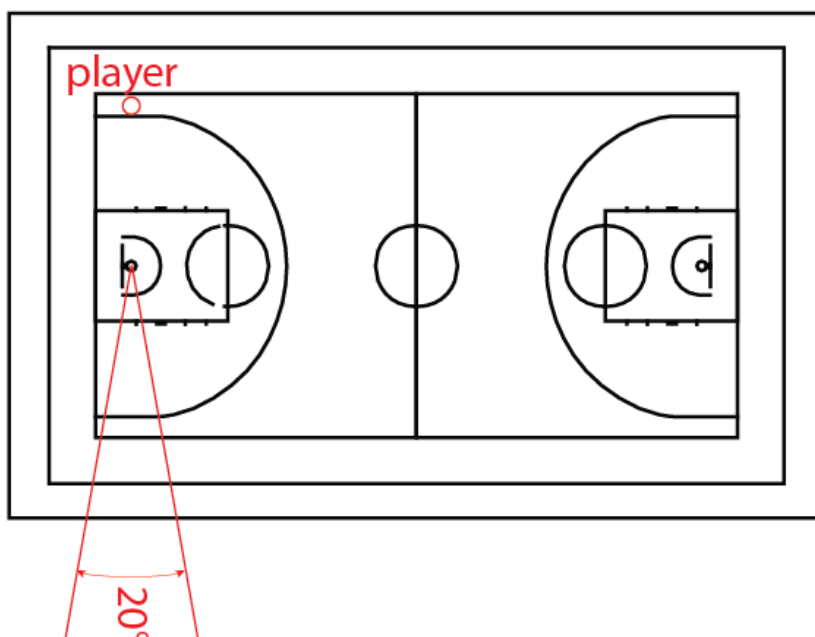

### 13 Whistle-controlled timing system

- 13.1 A whistle-controlled timing system, interfaced with the connector equipped game clock may be used by the referees to stop the game clock, provided that this system is used in all of the games of a given competition. The referees shall also start the game clock; however, this is, at the same time, also done by the timer. All FIBA approved scoreboards may provide the interface with the whistle-controlled timing system.
- 13.2 The whistle-controlled timing system shall stop the game clock when the referee's whistle is blown, with a response time of 0.1 seconds or less.
- 13.3 Coverage: The game clock must stop and restart according to the whistle-controlled timing system, at all locations on the basketball court.
- 13.4 The whistle-controlled timing system shall only stop the game clock upon the referee blowing the whistle and will not stop the game clock with any external whistle noise.

### 14 Whistle

- 14.1 The referee's whistle shall meet the decibel and frequency requirements outlined in Table 7.
- 14.2 The whistle shall:
- Be able to withstand repeated use at a high pressure (durability test).
  - Be able to withstand repeated dropping (damage test).

All readings shall be taken at 3 m from the front of the whistle.

Competition	Decibel at 8.3 kPa			Frequency range at 8.3 kPa		
	Initial test	Post durability test	Post damage test	Initial test	Post durability test	Post damage test
Level 1	≥ 105	≥ 105 & ± 10 % of pre-result		≥ 170	≥ 170 Hz & ± 10 % of pre-result	
Level 2	≥ 95	≥ 95 & ± 10 % of pre-result		≥ 150	≥ 150 Hz & ± 10 % of pre-result	

**Table 7 Whistle volume and frequency requirements**

- 14.3 Whistles shall be constructed of materials that do not cause a direct harm to the user. As such, the whistle shall conform to the requirements of the following, unless the local standards allow for deviations:
- EN 71 -3+A1:2014 Safety of toys – Part 3 migration of certain elements aluminium, antimony, arsenic, barium, cadmium, chromium(iii), chromium(vi), cobalt, copper, lead, manganese, mercury, nickel, selenium, strontium, tin and zinc.
  - PAH testing in line with REACH recommendations Annex XVII - Benzo[a]pyrene (BaP), Benzo[e]pyrene (BeP), Benzo[a]anthracene (BaA), Chrysen (CHR), Benzo[b]fluoranthene (BbFA), Benzo[k]fluoranthene (BkFA) & Dibenzo[a,h]anthracene (DBAha).
  - Phthalates testing in line with REACH recommendations Annex XVII – Di-2-ethyl-hexyl phthalates (DEHP), Diisononyl phthalate (DINP), Dibutyl phthalate (DBP), Di-n-octyl phthalate (DNOP), Benzylbutyl phthalate (BBP), and Diisodecyl phthalate (DIDP).

## **15 Advertising boards**

- 15.1 Advertising boards may be located around the court and:
- Shall be located at a minimum distance of 2,000 mm from the endlines and sidelines. They may be located on all sides around the court (Diagram 16 and 17).
  - Those along the endlines shall have a minimum gap of 900 mm on each side of the mobile backstop units so that the floor wiper(s) and portable TV camera(s) can pass through, if necessary, as well as providing an escape line for players.
  - Those along the table site shall have a minimum gap of 2,000 mm on each side of the scorer's table for the players, substitutes and coaches to pass through (Diagram 17).
  - For televised games they shall be located along the sidelines opposite the location of the main camera.
  - Are permitted in front of the scorer's table provided that they are placed directly in front of and horizontally and vertically flush with the table.
- 15.2 Advertising boards shall:
- Not exceed a height of 1,000 mm.
  - Be padded around the top and on the side edges with a minimum thickness of 20 mm (Diagram 15) and shall meet all player safety requirements outlined for backstop padding in Section 1.5.6.
  - Have no burrs and all edges and corners shall be rounded off.
  - Be in accordance with the national safety requirements for electrical equipment in the respective country.
  - Have mechanical protection for all engine driven parts.
  - Be non-flammable.
  - Be able to withstand direct impacts from basketballs, according to the Ball Impact Test.

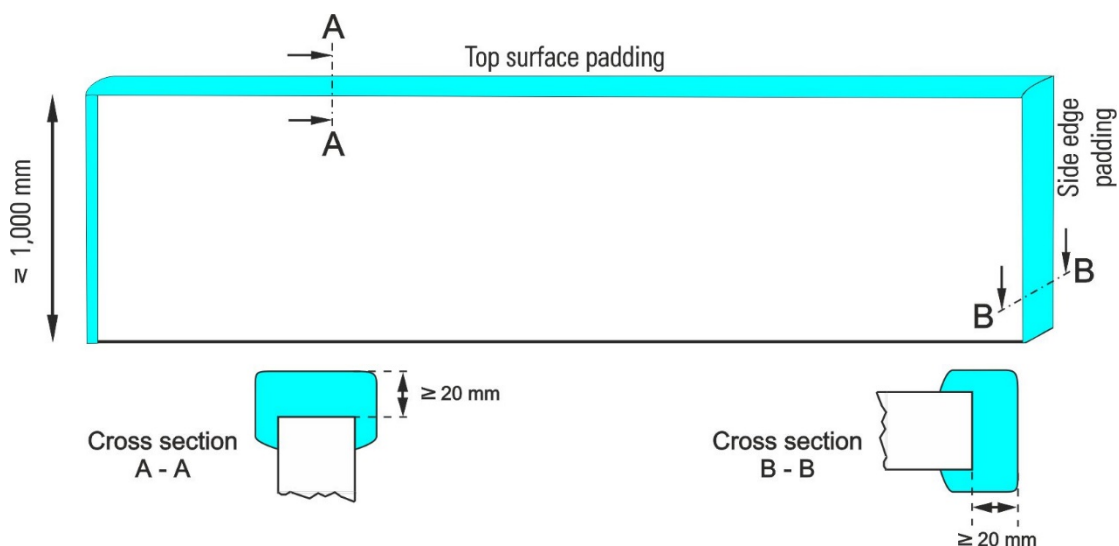

**Diagram 15 Advertising board padding**

15.3 For production purposes, it is recommended that the advertising boards shall have:

- The functionality to dim illuminance.
- A refresh rate of above 3,800 Hz.

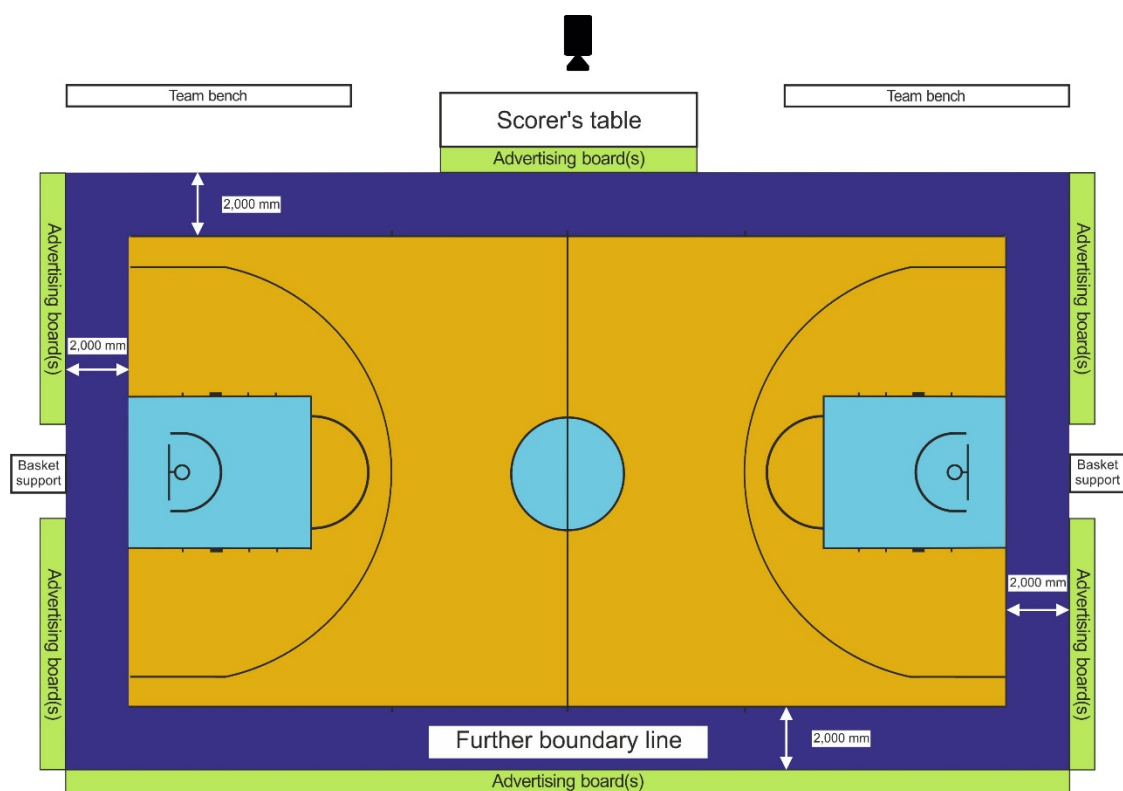

**Diagram 16 Advertising boards – main camera table side**

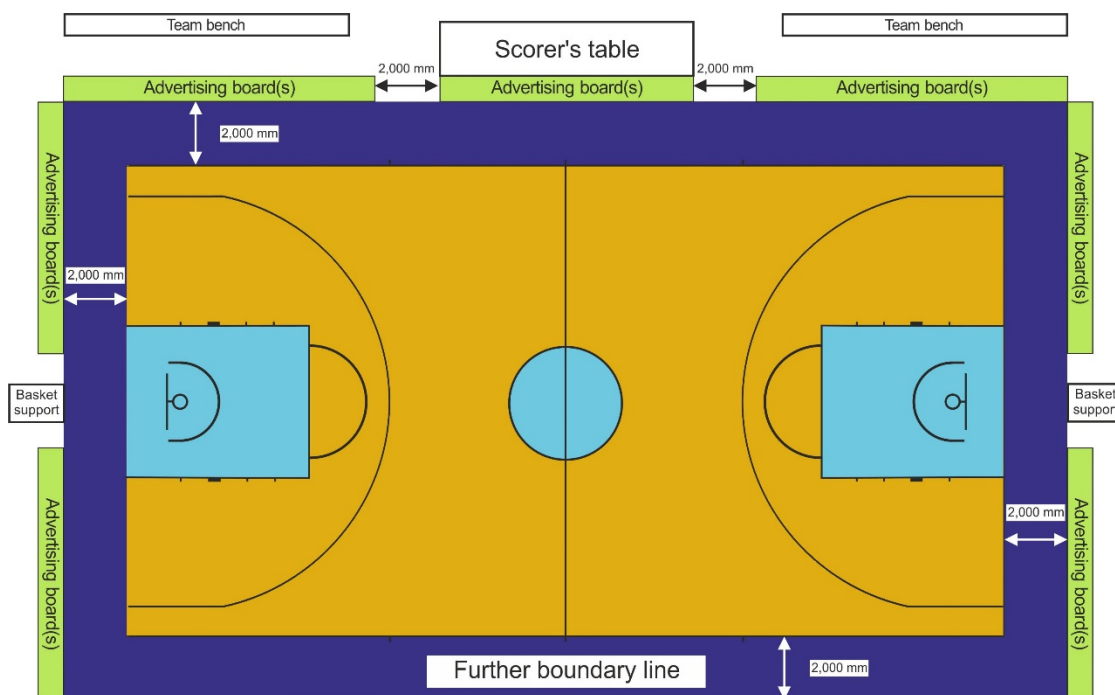

**Diagram 17 Advertising boards – main camera opposite side**

## 16 Spectator areas

The below specifications 16.2 - 16.6 are recommendations only. All components of the seat assembly shall comply fully with the relevant local and national rules and regulations.

16.1 The spectator areas shall:

- Allow the free movement of the public, including persons with a disability.
- Enable spectators to have a comfortable view of the event.
- Have unobstructed lines of visibility from all seats, as shown in Diagram 18, unless the local standards allow for deviations.
- Be designed without sharp edges/corners, for all accessible parts.

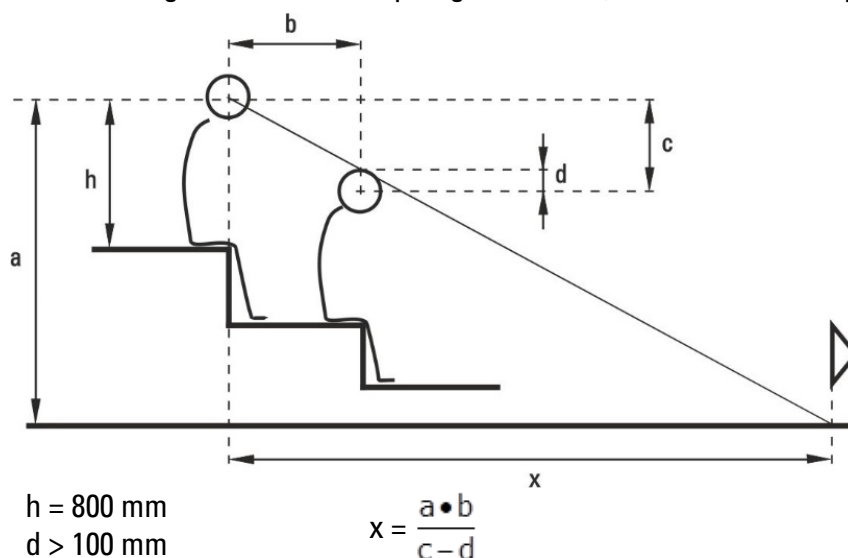

**Diagram 18 Spectators' line of visibility**

- 16.2 The seating capacity shall be defined as follows, unless the local standards allow for deviations:
- The total capacity of the sports hall is the total number of both the seated and standing positions.
  - The number of seated positions is the total number of seats or the total length of the terraces or benches in metres, divided by 480 mm.
  - The number of standing positions is the assigned floor space, with 35 spectators for every 10 m<sup>2</sup>.
- 16.3 The seating shall comply with the following, unless the local standards allow for deviations:
- The material of the different components of the seat shall comply the requirements described in the EN 13200-4: Spectator facilities. Seats. Product characteristics.
  - All metallic components, including fixings and fasteners required for installation shall be resistant to corrosion according to EN ISO 9227: Corrosion tests in artificial atmospheres. Salt spray tests.
  - All plastic components shall be resistant to atmospheric agents/light stability in accordance to EN ISO 4892-2: Plastics. Methods of exposure to laboratory light sources. Xenon-arc lamps.
  - All components of the seat assembly shall comply fully with the relevant national rules and regulations on fire safety for intended region(s) of sale and installation.
- 16.4 The following seating dimensions, with reference to Diagram 19, are recommended, unless the local standards specify deviations:
- F: Seat depth shall be no less than 350 mm.
  - Cse: Seat height shall be no more than 450 mm.
  - S: Recommended backrest height (if applicable) of 300 mm.

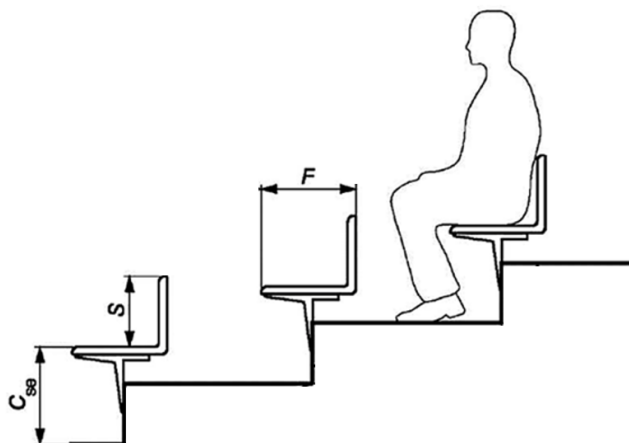

**Diagram 19 Spectator seating recommendations**

- 16.5 It is recommended the seating complies with the following test standards:
- Seat and Back Static Load Test, according to EN 1728
  - Seat Front Edge Static Load Test, according to EN 1728
  - Horizontal Forward Static Load Test on Back Rests, according to EN 1728
  - Vertical Load on Back, according to EN 1728
  - Arm Sideways Static Load, according to EN 1728
  - Arm Downwards Static Load, according to EN 1728
  - Combined Seat and Back Durability Test, according to EN 1728
  - Seat Front Edge Durability Test, according to EN 1728

- Back Horizontal Forward Durability Test, according to EN 12727.
- Arm Durability Test, according to EN 1728
- Seat Impact Test, according to EN 1728
- Arm Impact Test, according to EN 1728
- Back Impact Test, according to EN 1728
- Tipping Seat Operation Test, according to EN 1728.

16.6 Marking of the seating shall contain the following, unless the local standards allow for deviations:

- Name identification or trademark of the manufacturer
- Means of identification of the product
- Lot number
- Year of manufacture.

16.7 Telescopic and demountable stands shall be evaluated according to the national/local building codes and safety standards and shall comply with the following standards, unless the local standards allow for deviations:

- EN 13200-5. Spectator facilities. Part 5: Telescopic stands.
- EN 13200-6. Spectator facilities. Part 6: Demountable (temporary) stands.

Each project shall be validated by a qualified engineer by presentation of structural calculations and providing independent load test reports showing conformance to all national and regional standards and legislation.

## 17 References

- [1] FIBA Handbook of Test Methods and Requirements, FIBA Equipment and Venue Centre.
- [2] National Colour System of Standardiseringkommissionen i Sverige (SIS), Doc. No. SS019102.
- [3] RAL Colour Standard
- [4] EN 1270: Playing field equipment – Basketball equipment – Functional and safety requirements, test methods.
- [5] EN 14808: Surfaces for sports areas – Determination of shock absorption.
- [6] EN 14809: Surfaces for sports areas – Determination of vertical deformation.
- [7] EN 12235: Surfaces for sports areas – Determination of vertical ball behaviour.
- [8] EN 13036-4: Road and airfield surface characteristics – Test methods – Part 4: Method for measurement of slip/skid resistance of a surface – The pendulum test.
- [9] EN ISO 5470-1: Rubber- or plastic-coated fabrics – Determination of abrasion resistance – Part 1: Taber abrader.
- [10] EN 1569: Surfaces for sports areas – Determination of the behaviour under a rolling load.
- [11] EN 71-3+A1: Safety of toys – Part 3: Migration of certain elements aluminium, antimony, arsenic, barium, cadmium, chromium(iii), chromium (vi), cobalt, copper, lead, manganese, mercury, nickel, selenium, strontium, tin, and zinc.
- [12] REACH Recommendations: PAH Testing in line with REACH Recommendations Annex XVII – Benzo[a]pyrene (BaP), Benzo[e]pyrene (BeP), Benzo[a]anthracene (BaA), Chrysen (CHR), Benzo[b]fluoranthene (BbFA), Benzo[k]fluoranthene (BkFA) & Dibenzo[a,h]anthracene (DBAha).
- [13] REACH Recommendations: Phthalates Testing in line with REACH Recommendations Annex XVII – Di-2-ethylhexyl phthalates (DEHP, Diisononyl phthalate (DINP), Dibutyl phthalate (DBP), Di-n-octyl phthalate (DNOP), Benzylbutyl phthalate (BBP), and Diisodecyl phthalate (DIDP).
- [14] EN 13200-4: Spectator facilities – Seats – Product characteristics.
- [15] EN ISO 9227: Corrosion tests in artificial atmospheres – Salt spray tests.
- [16] EN ISO 4892-2: Plastics – Methods of exposure to laboratory light sources – Xenon-arc lamps.
- [17] EN 1728: Furniture – Seating – Test methods for the determination of strength and durability.
- [18] EN 12727: Furniture – Ranked seating – Requirements for safety, strength and durability.
- [19] EN 13200-5. Spectator facilities. Part 5: Telescopic stands.
- [20] EN 13200-6. Spectator facilities. Part 6: Demountable (temporary) stands.



**FIBA**

We Are Basketball

**FIBA** - International Basketball Federation  
5 Route Suisse, PO Box 29  
1295 Mies, Switzerland  
Tel: +41 22 545 00 00

**[fiba.basketball](http://fiba.basketball)**